

WEXCO

M A R I N E

WINDSHIELD WIPER KIT

Kit Contains:

Oscillating wiper motor
Adjustable wiper arm
Wiper blade
Blade adapter
Wiring diagram

Part numbers:

SQ112080SS
(12v, 80 degree wipe)

SQ112110SS
(12v, 110 degree wipe)

SQ124080SS
(24v, 80 degree wipe)

SQ124110SS
(24v, 110 degree wipe)

no suffix for white
"B" suffix for black
"V" suffix for silver

WEXCO
M A R I N E

Instructions for changing wipe angle on SQ series motors

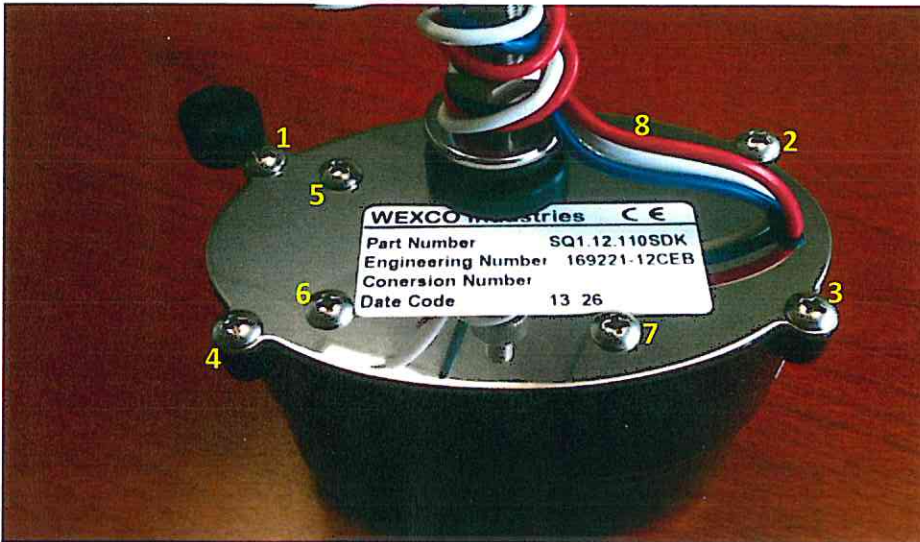

Upwrap the wires from around the shaft.
Remove the screws in the order 1-8.

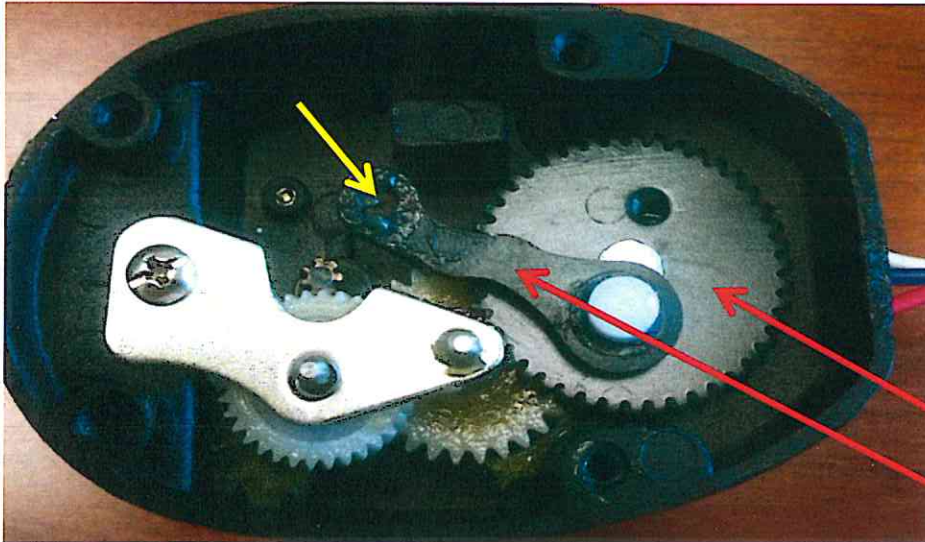

When the screws are removed, lift the silver plate up out of the motor can. As the top is lifted off, the pin on the motor crank will disengage from the hole in the link (where the yellow arrow is pointing).

Wipe Angle Plate
Link

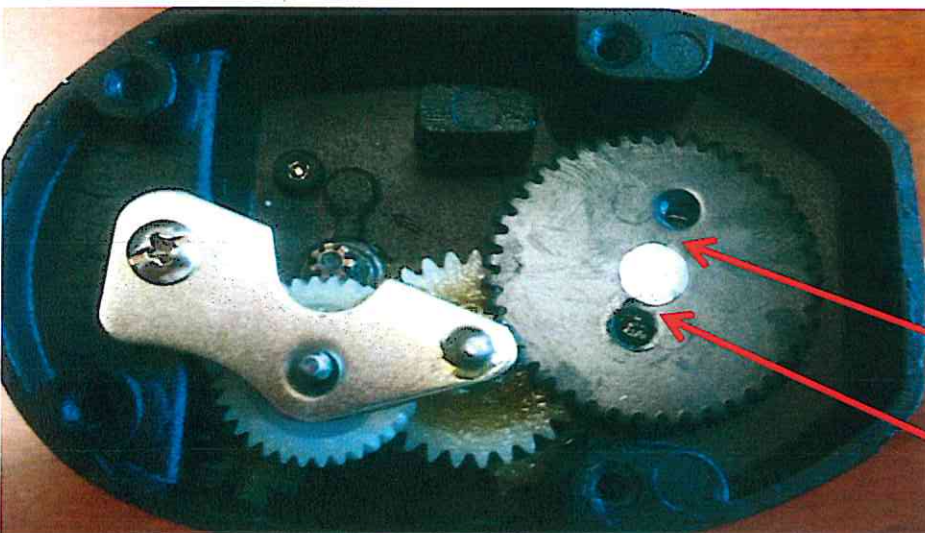

Remove the link from the Wipe Angle Plate by lifting it straight up. Depending on the production run, the Wipe Angle Plate may or may not be stamped with "80" and "110". Move the link into the desired hole.

7.7mm center-to-center distance; indicates 110 degrees
6.6mm center-to-center distance; indicates 80 degrees

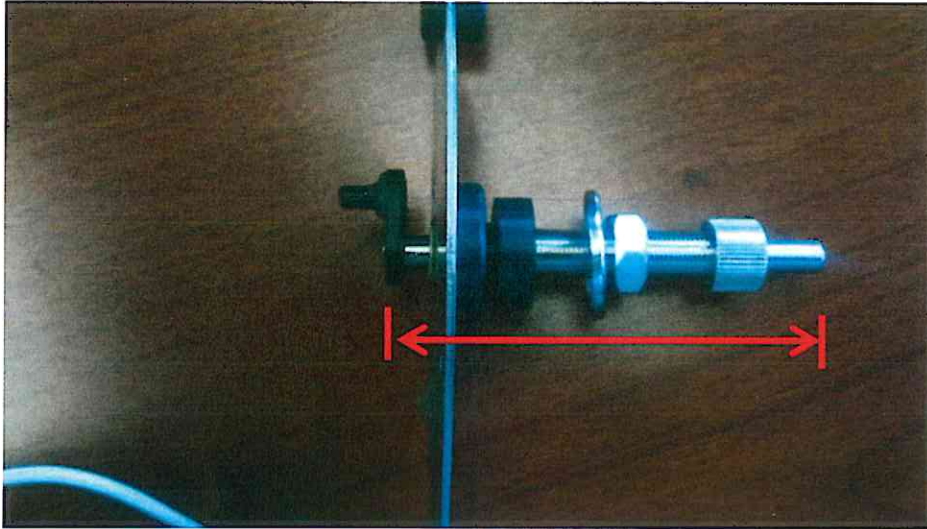

With the plate on its side, notice the motor shaft position.

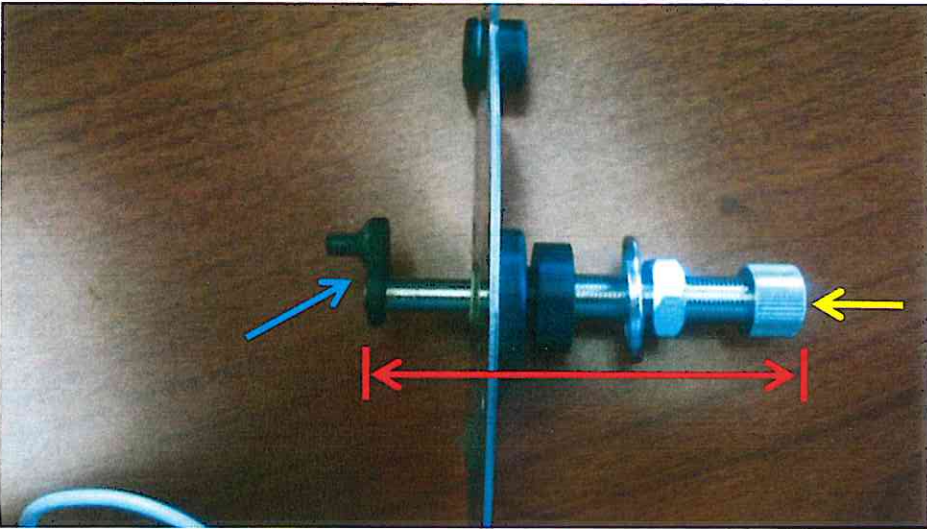

Push the motor shaft in the direction of the yellow arrow, so that the crank (light blue) is moved away from the motor plate. Positioning the crank here will make re-assembly easier.

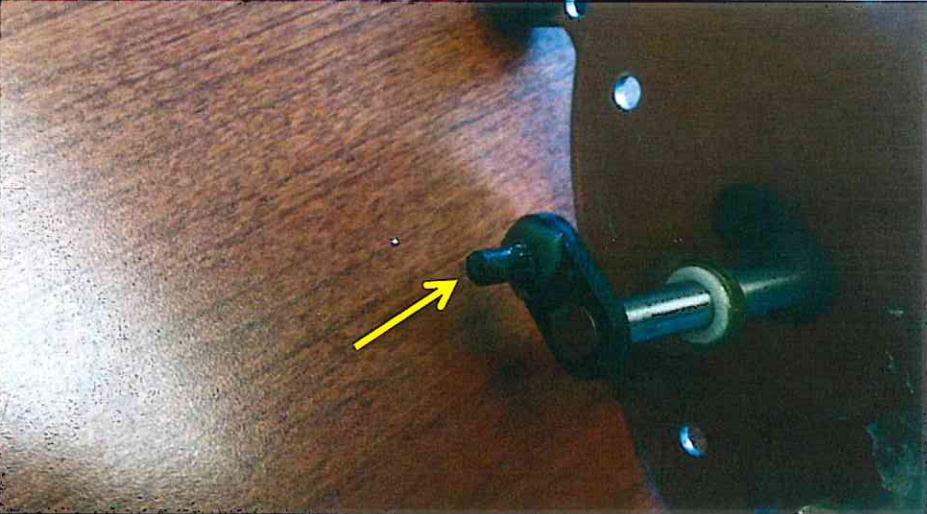

The pin (indicated by the yellow arrow) will need to be positioned into the end of the link.

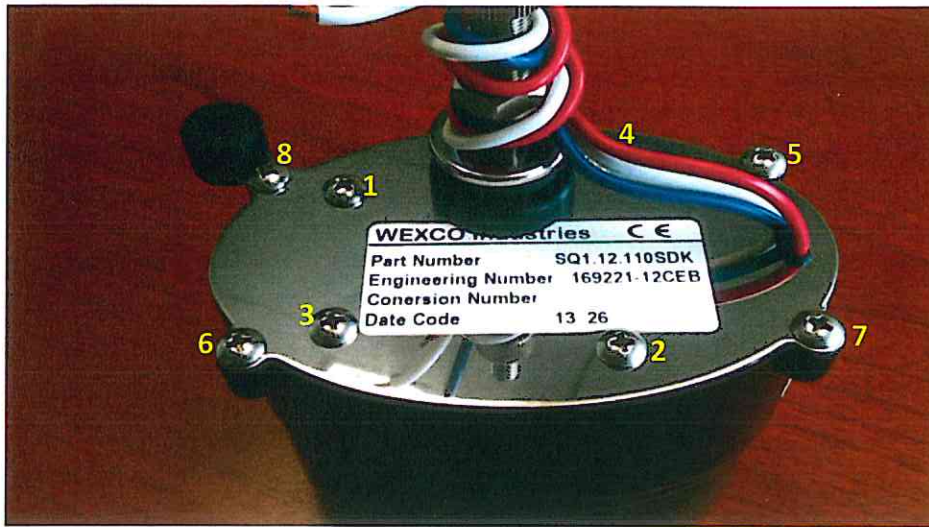

Once the pin on the crank is positioned into the link, push the motor plate flush against the motor can, and re-tighten the screws, in number order.

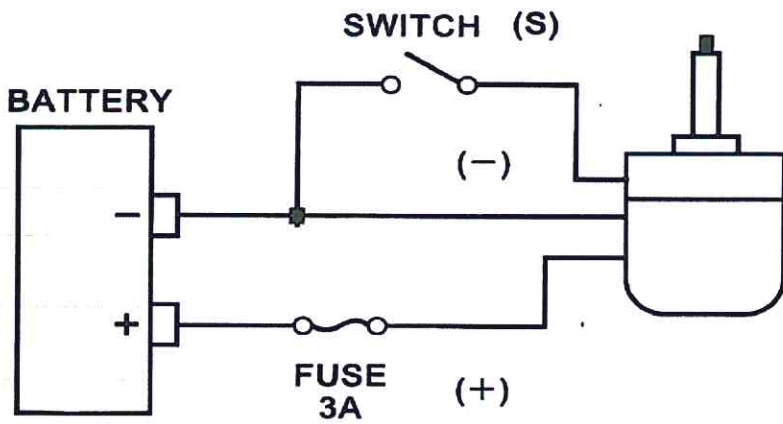

IP65 Waterproof Windshield Wiper Motor

- Capable of running 14" arms and 14" blades
- Changeable park position (right/left)
- Changeable sweep angle (80 degrees /110 degrees)
- Insulated ground makes it suitable for steel, aluminum, wood, and GRP boats
- Stainless steel drive shaft
- Waterproof